

INSTALLATION GUIDELINES for Homogeneous SHEET

1. INTRODUCTION

Homogeneous Sheet products (SHEET) designed and produced by LG HAUSYS (LGH), are interior floorcovering products for glue down application compliant with the regional rules.

2. PRIOR TO INSTALLATION

Storage

SHEET must be stored standing up in a dry and ventilated area. Do not store the rolls in very cold (less than 0°C) or very warm (more than 35°C) or humid area.¹ Also, do not store the rolls laying down on the floor nor stack the rolls up on top of each other.²

Inspection:

Despite the care and rigor during production, a visual inspection of the materials before installation is recommended, such as, batch number, reference, colour, design, and for differences or defects, to prevent from installation of false materials.³

In case any visual faults are detected on materials, do not install the faulty products and contact your local dealer, to obtain information about the way of proceeding.

LGH recommends to install products with the same batch/lot number only in the same area.⁴

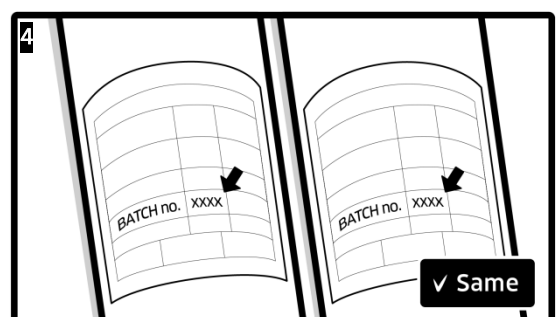
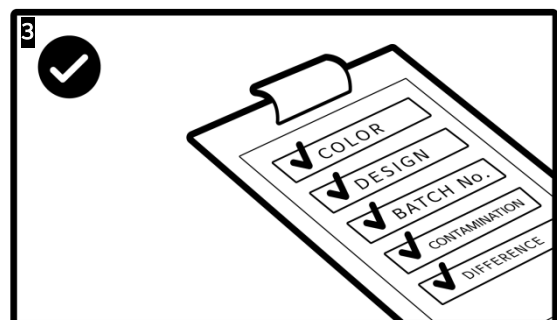
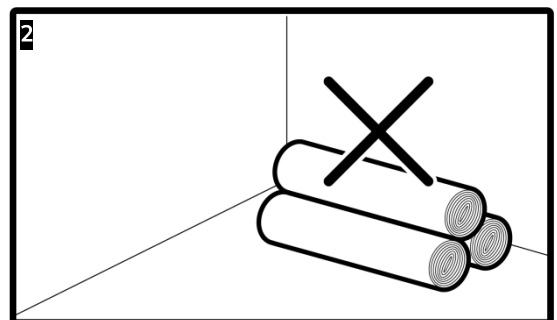
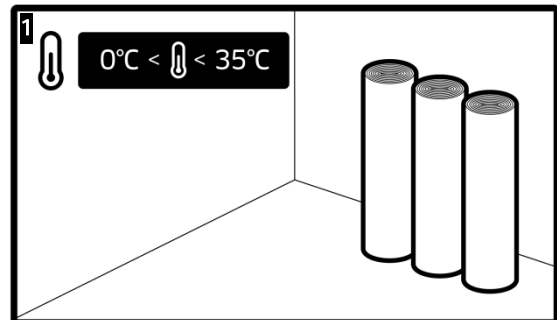

3. PREPARATION

For dimensional stability, you need to leave adhesive and rolls in the installation area at room temperature (18~32 °C) for at least one day standing up the rolls.⁵

Floor Prep:

The floor needs to be dry, clean, smooth, leveled, and the intensity of surface mortar should be sufficient.

Please remove foreign particles such as dust and sands.⁶

Sufficient cure by operating a heater before installation and repair works for cracked, sunken, or contaminated areas are required, especially for new buildings.⁷

Measure five or more spots randomly. The average value should be less than 5%.⁸

In case the floor condition is not good enough, apply primer or proceed self-levelling to reinforce floor smoothness and surface strength.

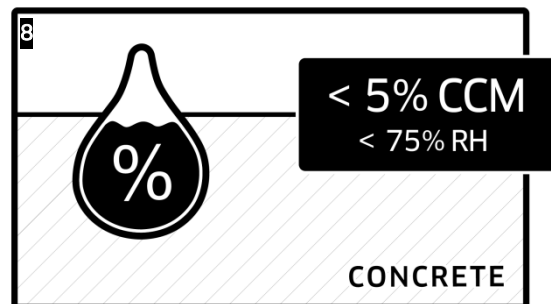
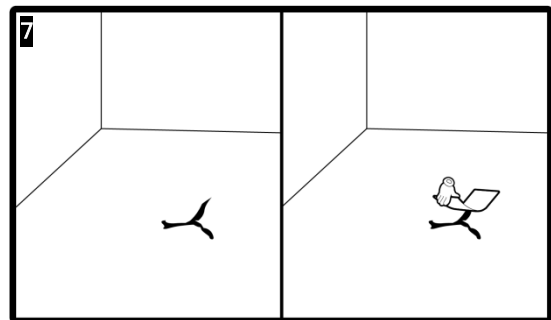
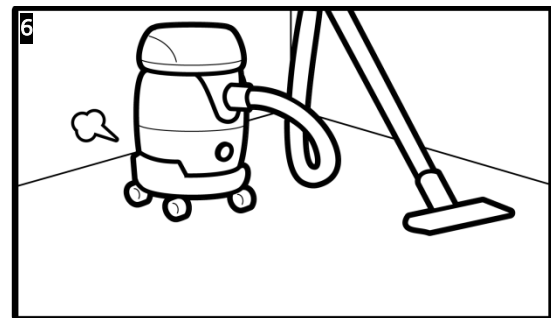
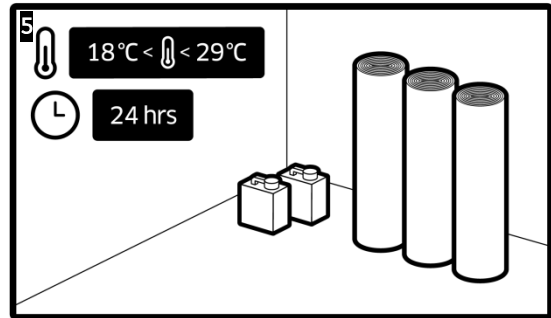

4. INSTALLATION

Before installation, please check lot/batch number on the label attached on the product package first, and make sure to use the products in identical number.⁹

Please estimate the installation direction and quantity. About 10cm longer than actual needed quantity should be cut.

Acclimation

Lay down the cut sheet on the floor for acclimation facing up, and minimum of 24 hrs at 18~29 °C is suggested.¹⁰

Cutting

Because the product may not be perfectly aligned with the wall, two of the following cutting methods can be utilized depending on the site situation: One is knife-cutting for simple installation, and the other is scribe-cutting for precise installation.¹¹

First, Please select installation position of the base sheet. Lay the sheet to the wall, and then mark about 10~15cm away from the sheet.

After adjusting a long scribe with a certain distance from the wall, mark a groove on the sheet surface pulling down the long scribe along the wall. Cut along the groove of the long scribe using a hook-shaped knife. Finally, cut the product completely to the bottom using a knife.

Once the cutting in the wall side is finished, place the sheet toward the wall and trim both edges.

Regional requirements could be different, so please check the local or national requirements before installation.

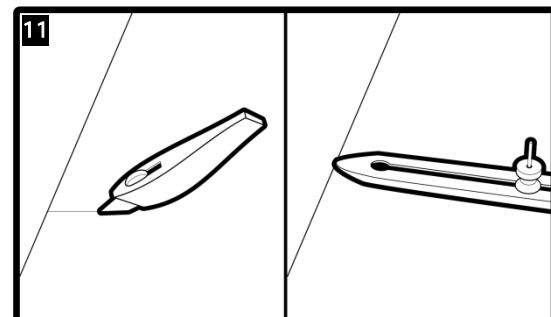
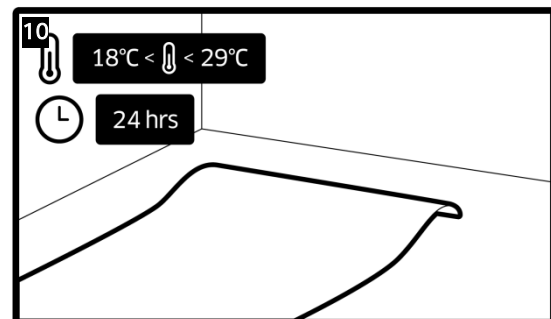
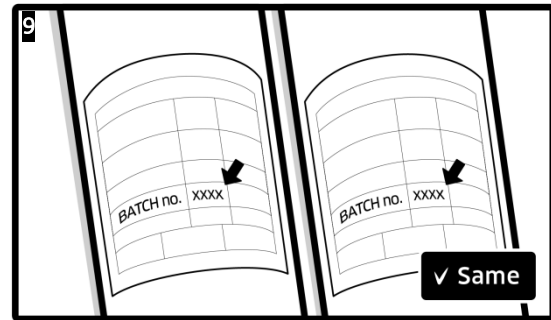

First, draw a line along with the base line, then mark "+" in the middle of the line. After moving the sheet along the drawn line, mark a groove on the sheet surface pulling down the long scribe along the wall. Cut along the groove of the long scribe using a hook-shaped knife. Repeat above procedure for the other side.

Please check if sheet lays on "+" mark exactly after returning the sheet.

Bonding

After the cutting, conduct bonding procedure using the adhesive and adhesive spreader. For commercial space, full-spread adhesion is required.

Please apply adhesive on the floor for the half of the first sheet. 20 minutes later, check adhesion and then unfold the sheet to complete.

Reverse Installation

From the 2nd sheet, install in reverse direction is required.¹²

Lay the second sheet next to the base sheet, overlap both designs matching their dotted lines to prepare cutting.

In order to match the joint areas of the sheet accurately, please use an edge trimmer.

After cutting the end of the installed first sheet based on the cut second sheet, remove leftover pieces from the cut area.

Install the rest of width area in the same process.

When the installation is finished, press floor thoroughly using a pressure roller to prevent defects such as excitation.¹³

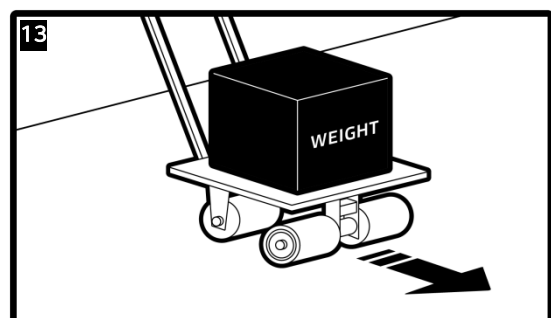
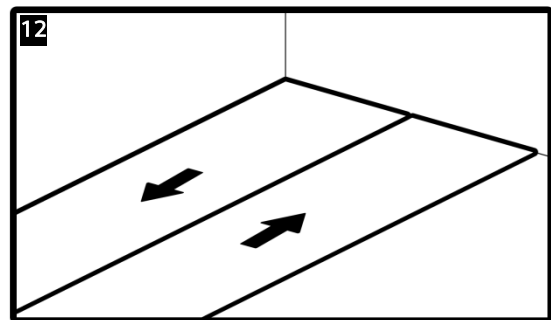

Welding

Make sure to apply welding on the joint areas to prevent water permeation.

Welding procedure should be conducted when the adhesive is fully cured. (normally 24 hours after installation)

The depth of welding groove should be 2/3 of sheet thickness.

Insert the welding rod colour suitable to each sheet into the nozzle of the welding gun, and increase the temperature of welding gun up to 220 °C (428 °F).¹⁴

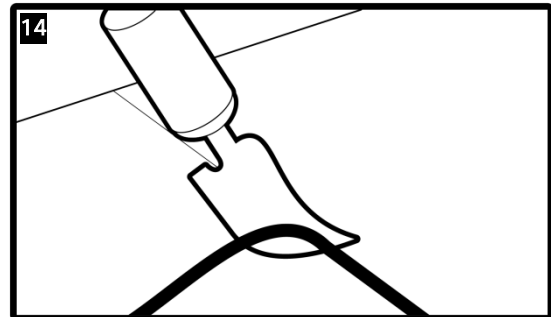

After conducting welding on the floor with adequate speed, trim protrusions before the welding rod cools down completely.¹⁵

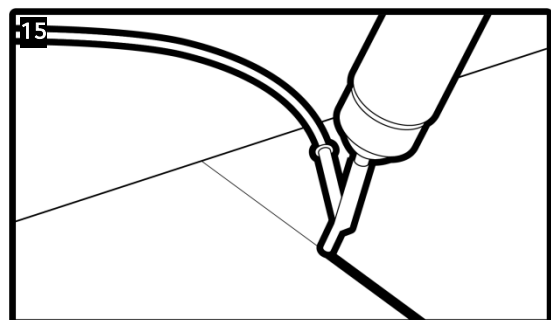

Depending on the site situation, conduct silicon process or install fixing skirts on the wall.¹⁶

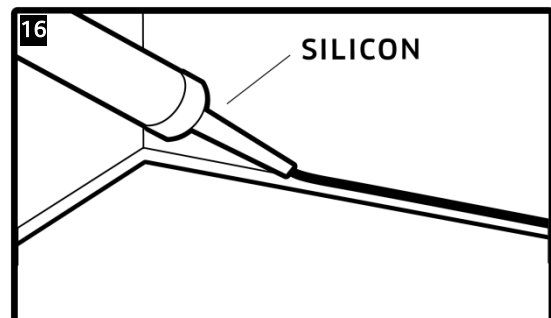

5. Protection and open to traffic

SHEET needs to be protected from heavy traffic for 48 hours to have a perfect adhesive stabilisation time. Light Pedestrian traffic is allowed. All other operation as furniture installation need to be postponed for the next 48 hours.¹⁷

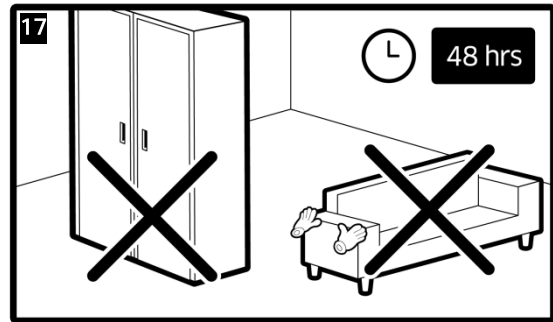

6. First Cleaning after installation

Prior to open the area to the normal traffic, LGH recommends to clean the surface using vacuum cleaner.¹⁸

To keep SHEET in perfect condition, LGH recommends regular cleaning and maintenance with the right cleaning process.

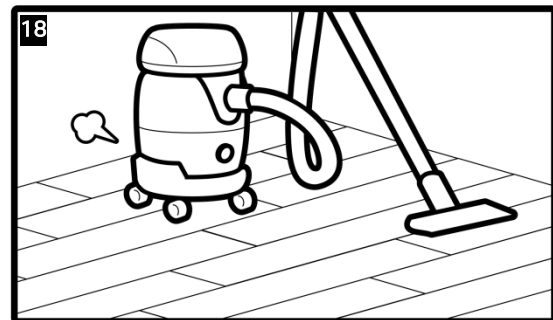

During furniture installation or movements, LGH recommend to protect the floorcovering and equipped the furniture legs with adapted pad.

The product needs to be protected for long time exposure of direct sunlight. Windows and Glass doors need to be covered properly to protect the nearby floorcoverings.¹⁹

If the products are installed in front of exterior access doors or windows, an entrance mat needs to be utilized.

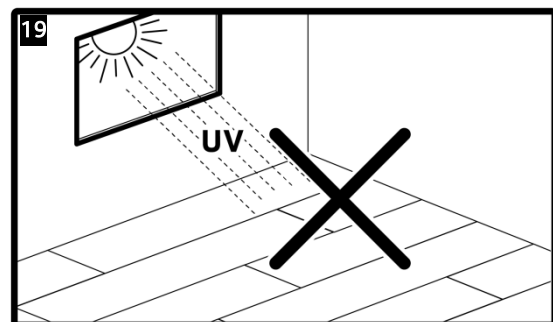

For additional information or advices about cleaning and protection, please refer to LGH cleaning guidelines.